

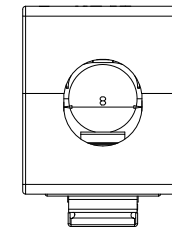

CAT6A Class EA RJ45 plug to be assembled in the field

- FTP TYPE: 1 piece Design
- Easy Assembly - easily terminated in the field in 2 minute without any special tools
- Operation temperature:-40°C to 60°C, Relative humidity: 85%(30°C), Air pressure: 70-106Kpa.
- Gold Plated Phosphor Bronze Blade: phosphor bronze and gold plating (3~50inches), mating durability not less than 750 cycles ;
- Anti-burn performance: product made from Kirsite \ PC
- Intermediate resistance: no more than 20m ohm in normal atmosphere pressure (not including bulk resistor) ;
- Insulated resistance: no less than 1,000M ohm in normal atmosphere pressure ;
- Retention strength: 7.7kg between jack and plug.
- Label: clear label to ensure easy to management ;
- Wire Connection: Stranded wire AWG 24/7 to 22/7
- Wire Connection: Solid wire AWG 24/1 to 22/1

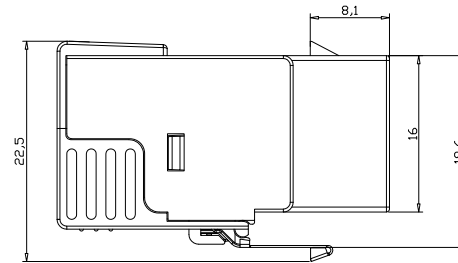
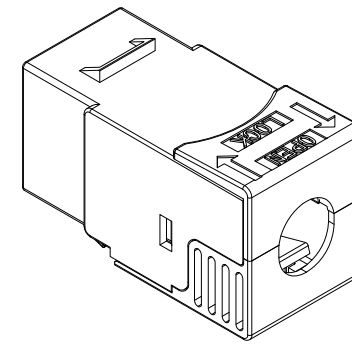
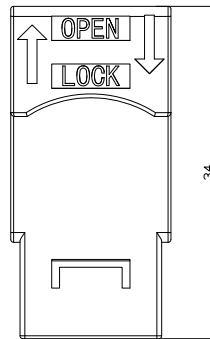
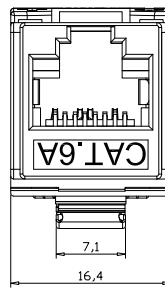
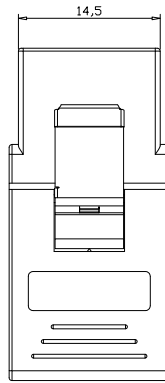

TITLE:			 CopperLed Technology Co., Limited	
	INCH	MM		
.X	.015	.30		
.XX	.010	.10		
.XXX	.005	.05		
DRAWN BY			P/N: CL-KJ-C6A18	
CHECK BY			SCALE	1:1
APPD BY			UNIT	MM
			SHEET	1/1
			DATE	2023/7/1
			DWG NO:	

1

2

3

4

5

6

A

B

C

D

A

B

C

D

1

2

4

5

6